

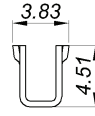

Özel Tip Terminaller *Special Purpose Terminals*

Özel Tip Terminaller / *Special Purpose Terminals*

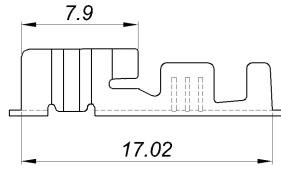

Ürün Adı Product Name	Ürün Kodu Product Code	Malzeme Kalınlığı (mm) Material Thickness (mm)	Kablo Kesiti (mm ²) Wire Size (mm ²)	Form	Malzeme / Material			Adet / SPQ	
					CuZn	CuSn	CuNiSi	Rulo / Chain	Dökme / Loose
PIM TERMINAL-3	0XXXX06078	0,40	0,80-1,50	-	●	●	*	5.000	-

Kullanıldığı Konnektörler / Used with insulation housing	Sayfa / Page
PIM Terminal Konnektörü / PIM Insulation Housing	0XXXX40044-1 13-9

Kaplama / Plating		
Sn	Ni	Ag
✓	✓	✓

- Standart Ürün / Standard Part
- * Talep Üzerine / Available on request

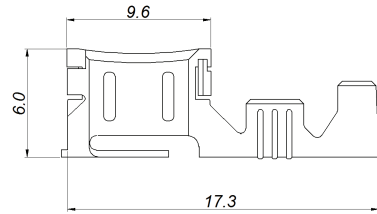

Ürün Adı Product Name	Ürün Kodu Product Code	Malzeme Kalınlığı (mm) Material Thickness (mm)	Kablo Kesiti (mm ²) Wire Size (mm ²)	Form	Malzeme / Material			Adet / SPQ	
					CuZn	CuSn	CuNiSi	Rulo / Chain	Dökme / Loose
EKOTER2	0XXXX06003	0,40	0,50-1,00	-	-	-	●	5.000	-

- Standart Ürün / Standard Part
- * Talep Üzerine / Available on request

Kaplama / Plating		
Sn	Ni	Ag
✓	✓	✓

Özel Tip Terminaller / *Special Purpose Terminals*

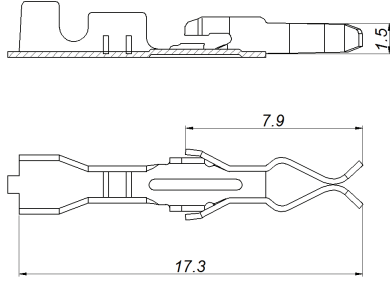

Ürün Adı Product Name	Ürün Kodu Product Code	Malzeme Kalınlığı (mm) Material Thickness (mm)	Kablo Kesiti (mm ²) Wire Size (mm ²)	Form	Malzeme / Material			Adet / SPQ	
					CuZn	CuSn	DC	Rulo / Chain	Dökme / Loose
TVT1	0XXXX06005-00	0,25	0,10-0,30	-	●	-	-	10.000	-

Kullanıldığı Konnektörler / Used with insulation housing	Sayfa / Page
TVT1 Konnektörü / TVT1 Insulation Housing	0XXXX40014-0 13-9

Kaplama / Plating		
Sn	Ni	Ag
✓	✓	✓

- Standart Ürün / Standard Part
- * Talep Üzerine / Available on request

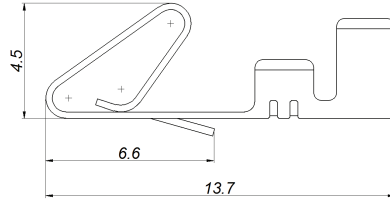

Ürün Adı Product Name	Ürün Kodu Product Code	Malzeme Kalınlığı (mm) Material Thickness (mm)	Kablo Kesiti (mm ²) Wire Size (mm ²)	Form	Malzeme / Material			Adet / SPQ	
					CuZn	CuSn	DC	Rulo / Chain	Dökme / Loose
TVT3	0XXXX06014	0,25	0,50-1,00	-	-	●	-	5.000	-

- Standart Ürün / Standard Part
- * Talep Üzerine / Available on request

Kaplama / Plating		
Sn	Ni	Ag
✓	✓	✓

Özel Tip Terminaller / *Special Purpose Terminals*

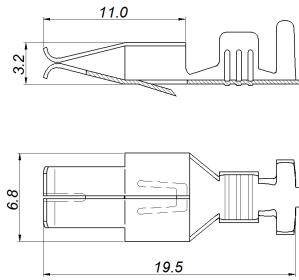

Ürün Adı Product Name	Ürün Kodu Product Code	Malzeme Kalınlığı (mm) Material Thickness (mm)	Kablo Kesiti (mm ²) Wire Size (mm ²)	Form	Malzeme / Material			Adet / SPQ	
					CuZn	CuSn	DC	Rulo / Chain	Dökme / Loose
SF29DK-V	0XXXX06008	0,32	0,50-1,00	-	●	*	-	2.500	5.000
SF29D-V	0XXXX06007	0,32	1,00-2,50	-	●	*	-	2.500	5.000
SF29DB-V	0XXXX06047	0,32	1,00-2,50	-	●	*	-	2.000	5.000

Kullanıldığı Konnektörler / Used with insulation housing		Sayfa / Page
USK M1-A1 / M1-A1 Insulation Housing	0XXXXX40021-0	13-9
USK M1-A2 / M1-A2 Insulation Housing	0XXXXX40022-0	13-9
USK M1-A3 / M1-A2 Insulation Housing	0XXXXX40023-0	13-10
USK M1-A4 / M1-A2 Insulation Housing	0XXXXX40024-0	13-10
USK M1-A2A3 4'lü / M1-A2A3 Insulation Housing	0XXXXX40060-0	13-10

Kaplama / Plating		
Sn	Ni	Ag
✓	✓	✓

- Standart Ürün / Standard Part
- * Talep Üzerine / Available on request

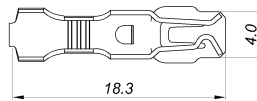
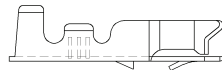

Ürün Adı Product Name	Ürün Kodu Product Code	Malzeme Kalınlığı (mm) Material Thickness (mm)	Kablo Kesiti (mm ²) Wire Size (mm ²)	Form	Malzeme / Material			Adet / SPQ	
					CuZn	CuSn	DC	Rulo / Chain	Dökme / Loose
FAR TERMINAL-IZK-2	0XXXX06042	0,40	0,50-0,75	-	●	-	-	4.000	-

- Standart Ürün / Standard Part
- * Talep Üzerine / Available on request

Kaplama / Plating		
Sn	Ni	Ag
✓	✓	✓

Özel Tip Terminaller / *Special Purpose Terminals*

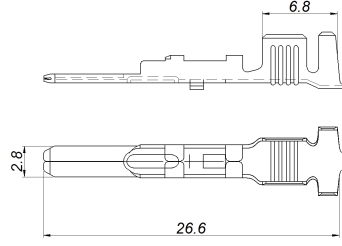

Ürün Adı Product Name	Ürün Kodu Product Code	Malzeme Kalınlığı (mm) Material Thickness (mm)	Kablo Kesiti (mm ²) Wire Size (mm ²)	Form	Malzeme / Material			Adet / SPQ	
					CuZn	CuSn	DC	Rulo / Chain	Dökme / Loose
KT01EK (2.8)	0XXXX01131-00	0,32	0,30-1,00	-	●	*	-	5.000	-
KT01EB (2.8)	0XXXX01163-00	0,32	1,00-3,00	-	●	*	-	3.500	-

- Standart Ürün / Standard Part
- * Talep Üzerine / Available on request

Kaplama / Plating		
Sn	Ni	Ag
✓	✓	✓

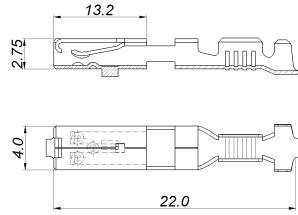

Ürün Adı Product Name	Ürün Kodu Product Code	Malzeme Kalınlığı (mm) Material Thickness (mm)	Kablo Kesiti (mm ²) Wire Size (mm ²)	Form	Malzeme / Material			Adet / SPQ	
					CuZn	CuSn	DC	Rulo / Chain	Dökme / Loose
KT01DK	0XXXX06016-00	0,32	0,35-1,00	-	-	●	-	5.000	-
KT01DB	0XXXX06031-00	0,32	1,00-3,00	-	-	●	-	3.500	-

Kullanıldığı Konnektörler / Used with insulation housing	Sayfa / Page
13'lü KT01D Konnektör / KT01D Housing (13 Poles)	0XXXX40014-0 13-16

Kaplama / Plating		
Sn	Ni	Ag
✓	✓	✓

- Standart Ürün / Standard Part
- * Talep Üzerine / Available on request

Özel Tip Terminaller / *Special Purpose Terminals*

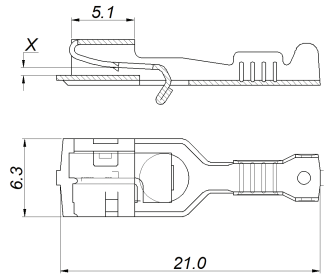

Ürün Adı Product Name	Ürün Kodu Product Code	Malzeme Kalınlığı (mm) Material Thickness (mm)	Kablo Kesiti (mm ²) Wire Size (mm ²)	Form	X	TAB	Malzeme / Material			Adet / SPQ	
							CuZn	CuSn	DC	Rulo / Chain	Dökme / Loose
SF40DK (4.8)	0XXXX04326-00	0,40	0,35-1,00	-	0,25	0,80	-	●	-	5.000	-
SF40D (4.8)	0XXXX04314-00	0,40	1,00-3,00	-	0,25	0,80	-	●	-	5.000	-

● Standart Ürün / Standard Part

* Talep Üzerine / Available on request

Kaplama / Plating		
Sn	Ni	Ag
✓	✓	✓

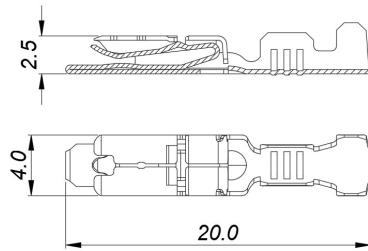

Ürün Adı Product Name	Ürün Kodu Product Code	Malzeme Kalınlığı (mm) Material Thickness (mm)	Kablo Kesiti (mm ²) Wire Size (mm ²)	Form	Malzeme / Material			Adet / SPQ	
					CuZn	CuSn	DC	Rulo / Chain	Dökme / Loose
SF41DK	0XXXX06044-00	0,30	0,35-1,00	-	-	●	-	5.000	-
SF41D	0XXXX06045-00	0,30	1,00-3,00	-	-	●	-	3.500	-

● Standart Ürün / Standard Part

* Talep Üzerine / Available on request

Kaplama / Plating		
Sn	Ni	Ag
✓	✓	✓

Özel Tip Terminaller / *Special Purpose Terminals*

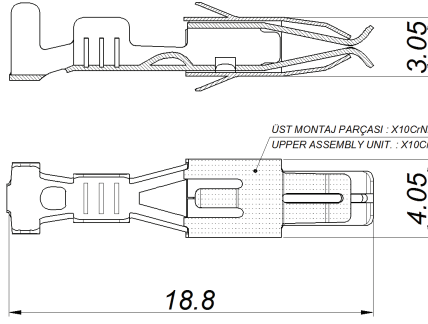

Ürün Adı Product Name	Ürün Kodu Product Code	Malzeme Kalınlığı (mm) Material Thickness (mm)	Kablo Kesiti (mm ²) Wire Size (mm ²)	Form	Malzeme / Material			Adet / SPQ	
					CuZn	CuSn	DC	Rulo / Chain	Dökme / Loose
SF42DK	0XXXX06046-00	0,30	0,50-1,00	-	-	●	-	5.000	-
SF42D	0XXXX06052-00	0,30	1,00-2,50	-	-	●	-	4.000	-

- Standart Ürün / Standard Part
- * Talep Üzerine / Available on request

Kaplama / Plating		
Sn	Ni	Ag
✓	✓	✓

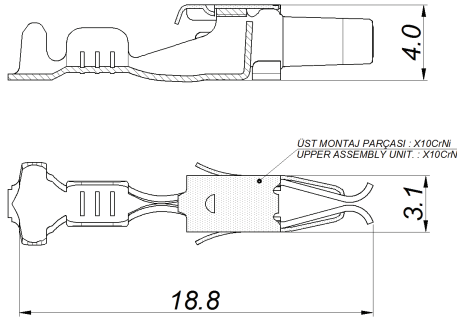

Ürün Adı Product Name	Ürün Kodu Product Code	Malzeme Kalınlığı (mm) Material Thickness (mm)	Kablo Kesiti (mm ²) Wire Size (mm ²)	Form	Malzeme / Material			Adet / SPQ	
					CuZn	CuSn	DC	Rulo / Chain	Dökme / Loose
SF43DK	0XXXX06048-00	0,32	0,50-1,00	-	-	●	-	4.000	-
SF43DB	0XXXX06053-00	0,32	1,00-3,00	-	-	●	-	3.500	-

- Standart Ürün / Standard Part
- * Talep Üzerine / Available on request

Kaplama / Plating		
Sn	Ni	Ag
✓	✓	✓

Özel Tip Terminaller / *Special Purpose Terminals*

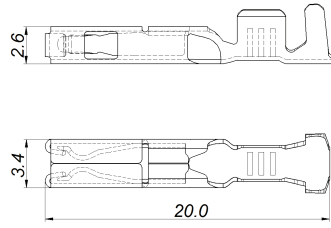

Ürün Adı Product Name	Ürün Kodu Product Code	Malzeme Kalınlığı (mm) Material Thickness (mm)	Kablo Kesiti (mm ²) Wire Size (mm ²)	Form	Malzeme / Material			Adet / SPQ	
					CuZn	CuSn	CuFe2P	Rulo / Chain	Dökme / Loose
SF45DK	0XXXX06051-00	0,30	0,35-0,75	-	-	*	●	5.000	-
SF45D	0XXXX06049-00	0,30	1,00-2,00	-	-	*	●	4.000	-
SF45DB	0XXXX06060-00	0,30	1,35-2,00	-	-	*	●	4.000	-

- Standart Ürün / Standard Part
- * Talep Üzerine / Available on request

Kaplama / Plating		
Sn	Ni	Ag
✓	✓	✓

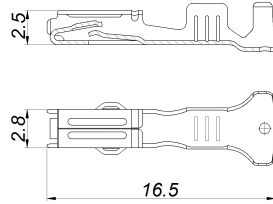

Ürün Adı Product Name	Ürün Kodu Product Code	Malzeme Kalınlığı (mm) Material Thickness (mm)	Kablo Kesiti (mm ²) Wire Size (mm ²)	Form	Malzeme / Material			Adet / SPQ	
					CuZn	CuSn	DC	Rulo / Chain	Dökme / Loose
SF46DK	0XXXX06062-00	0,30	0,20-0,50	-	●	-	-	5.000	-
SF46D	0XXXX06061-00	0,30	0,50-1,25	-	●	-	-	5.000	-

- Standart Ürün / Standard Part
- * Talep Üzerine / Available on request

Kaplama / Plating		
Sn	Ni	Ag
✓	✓	✓

Özel Tip Terminaller / *Special Purpose Terminals*

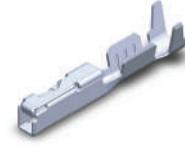
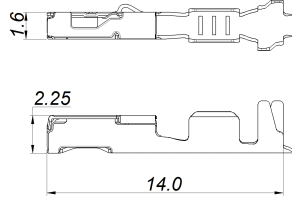

Ürün Adı Product Name	Ürün Kodu Product Code	Malzeme Kalınlığı (mm) Material Thickness (mm)	Kablo Kesiti (mm ²) Wire Size (mm ²)	Form	Malzeme / Material			Adet / SPQ	
					CuZn	CuSn	CuNiSi	Rulo / Chain	Dökme / Loose
SF47DK	0XXXX06066-00	0,20	0,35-0,50	-	-	-	●	10.000	-

- Standart Ürün / Standard Part
- * Talep Üzerine / Available on request

Kaplama / Plating		
Sn	Ni	Ag
✓	✓	✓

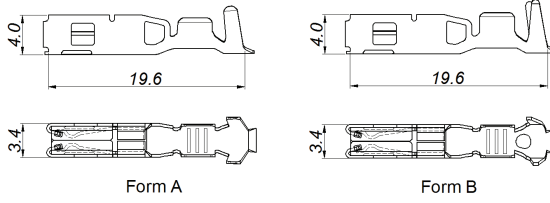

Ürün Adı Product Name	Ürün Kodu Product Code	Malzeme Kalınlığı (mm) Material Thickness (mm)	Kablo Kesiti (mm ²) Wire Size (mm ²)	Form	Malzeme / Material			Adet / SPQ	
					CuZn	CuSn	CuFe2P	Rulo / Chain	Dökme / Loose
SF48DK	0XXXX06065-00	0,28	0,35-0,75	A	*	*	●	3.000	-
SF48D	0XXXX06064-00	0,28	1,00-2,50	A	*	*	●	2.500	-
SF48D-SC	0XXXX06067-00	0,28	1,00-2,50	B	*	*	●	2.500	-

- Standart Ürün / Standard Part
- * Talep Üzerine / Available on request

Kaplama / Plating		
Sn	Ni	Ag
✓	✓	✓

Özel Tip Terminaller / *Special Purpose Terminals*

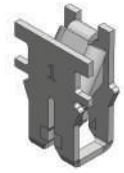
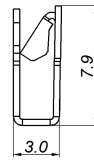
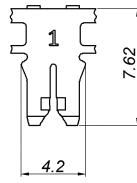

Ürün Adı Product Name	Ürün Kodu Product Code	Malzeme Kalınlığı (mm) Material Thickness (mm)	Kablo Kesiti (mm) Wire Size (mm)	Form	Malzeme / Material			Adet / SPQ	
					CuZn	CuSn	DC	Rulo / Chain	Dökme / Loose
HAT-MATE D1	0XXXX12001	0,40	0,64-0,81	-	●	-	-	10.000	-

● Standart Ürün / Standard Part

* Talep Üzerine / Available on request

Kaplama / Plating		
Sn	Ni	Ag
✓	✓	✓

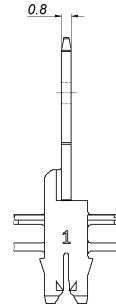
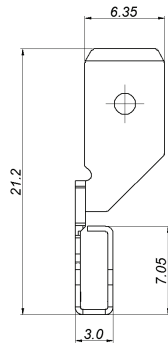

Ürün Adı Product Name	Ürün Kodu Product Code	Malzeme Kalınlığı (mm) Material Thickness (mm)	Kablo Kesiti (mm) Wire Size (mm)	Form	Malzeme / Material			Adet / SPQ	
					CuZn	CuSn	DC	Rulo / Chain	Dökme / Loose
HAT-MATE E1K	0XXXX12003	0,40	0,51-0,64	-	●	-	-	3.500	-
HAT-MATE E1	0XXXX12002	0,40	0,72-0,91	-	●	-	-	3.500	-

● Standart Ürün / Standard Part

* Talep Üzerine / Available on request

Kaplama / Plating		
Sn	Ni	Ag
✓	✓	✓

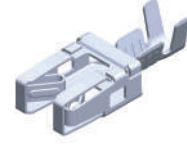
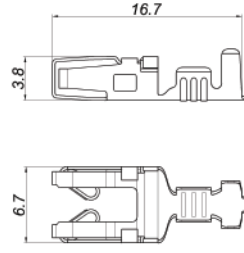
Özel Tip Terminaller / Special Purpose Terminals

Ürün Adı Product Name	Ürün Kodu Product Code	Malzeme Kalınlığı (mm) Material Thickness (mm)	Kablo Kesiti (mm ²) Wire Size (mm ²)	Form	Malzeme / Material			Adet / SPQ	
					CuZn	CuSn	CuNiSi	Rulo / Chain	Dökme / Loose
SF51DK	0XXXX06070	0,25	0,50-1,00	-	*	●	-	3.500	-

- Standart Ürün / Standard Part
- * Talep Üzerine / Available on request

Kaplama / Plating		
Sn	Ni	Ag
✓	✓	✓